

A FAST-READING DIGITAL VOLTMETER WITH 0.005% ACCURACY AND INTEGRATING CAPABILITY

A new Digital Voltmeter of very high accuracy makes readings from less than 100 μVdc to 1000 Vdc at maximum speeds of up to 15 readings per second.

DIGITAL VOLTMETERS have found growing acceptance during the past decade because of the many useful advantages they provide. These instruments measure dc voltages with a combination of speed and accuracy not found in other types of instruments or systems, and do so with a remarkable simplicity of operation. Operator errors are reduced because of the easily-interpreted digital presentation and because of the automatic ranging and polarity selection. Furthermore, remote programming and data storage capabilities enable digital voltmeters to serve in automatic systems for repetitive measurements of many variables.

Early digital voltmeters used a null balance or potentiometric system to convert the unknown voltage into a digital presentation of that voltage. These instruments, however, were relatively slow-responding and expensive. In a step towards achieving speed and accuracy at reduced cost, Hewlett-Packard in 1959 developed a digital voltmeter which functions by measuring the time required for an internal linear voltage ramp to pass from a reference level to a level equal to the unknown dc input voltage.¹ This time

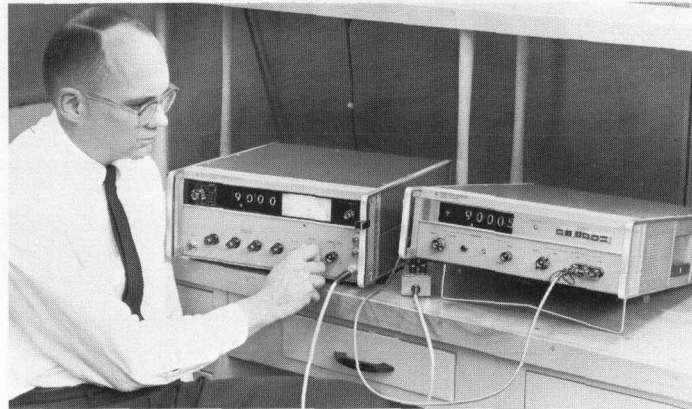

Fig. 1. New *-hp-* Model 3460A Digital Voltmeter, designed for either bench service or systems use, achieves standards lab accuracy with operating simplicity. Guarding preserves accuracy by eliminating effects of common-mode signals and instrument also has noise rejection properties of signal integration. As shown here, 0.005% accuracy of new digital voltmeter is such that it tracks output of dc voltage standard digit by digit.

interval, which is proportional to the input voltage, is measured by a built-in electronic counter to obtain a digital indication of the input voltage. The basic simplicity of the ramp technique has resulted in reliable and economical voltmeters with typical accuracies of better than 0.05%.²

¹ Theodore C. Anderson and Noel M. Pace, "A New Digital DC Voltmeter with Automatic Range and Polarity Selection," *Hewlett-Packard Journal*, Vol. 10, No. 5, Jan. 1959.

² David S. Cochran and Charles W. Near, "A New Multi-Purpose Digital Voltmeter," *Hewlett-Packard Journal*, Vol. 15, No. 3, Nov., 1963.

Improvements with time have increased the ability of the digital voltmeter to cope with a variety of measurement problems. A serious problem has been the effects of superimposed noise on the accuracy of measurement. To permit successful and accurate readings in the presence of noise, a large amount of filtering was usually added at the input, although this limits measuring speed by slowing response.

In an unusual approach towards combating the problems of superimposed noise, the Dymec Division of Hewlett-Packard developed a new type of digital voltmeter in 1961.³ The Dymec voltmeter uses a voltage-to-frequency converter to generate a train of pulses at a repetition rate proportional to the instantaneous value of the input voltage. The pulses are accumulated in a counter during a fixed period of time to obtain the digital read-out. This technique integrates noise superimposed on the input signal, providing a reading that is a true average of the

³ R. A. Andersen, "A New Digital Voltmeter Having High Rejection of Hum and Noise," *Hewlett-Packard Journal*, Vol. 13, No. 6, Feb., 1962.

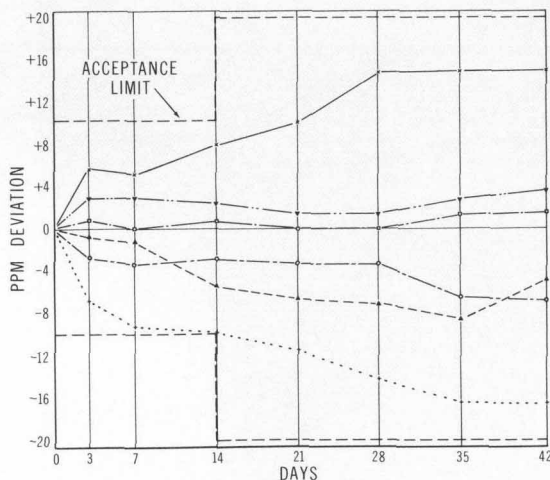

Fig. 2. Curves show stabilities of typical reference supplies during initial 1000-hour test. To be acceptable for installation in new digital voltmeter, reference supply voltage must not deviate more than 10 ppm during first 14 days of test and no more than an additional 10 ppm during remainder of test.

Fig. 3. DY-2015J Data Acquisition System, developed by Dymec Division of Hewlett-Packard, is typical of standard data acquisition systems that use new Model 3460A Digital Voltmeter. System shown here, which has guarded input circuitry, accepts up to 200 3-wire inputs and records up to 12 readings per second in IBM-compatible magnetic tape format. System accuracy, when reading dc voltages, is same as Model 3460A Voltmeter: $\pm 0.005\%$ of reading $\pm 0.002\%$ of full scale over temperature range of $+10$ to 40°C . Other similar systems couple directly to card punch, tape punch, or to paper tape printer. Additional equipment permits resistance and ac voltage measurements, manual data entry, go/no-go comparisons, and time of day entries.

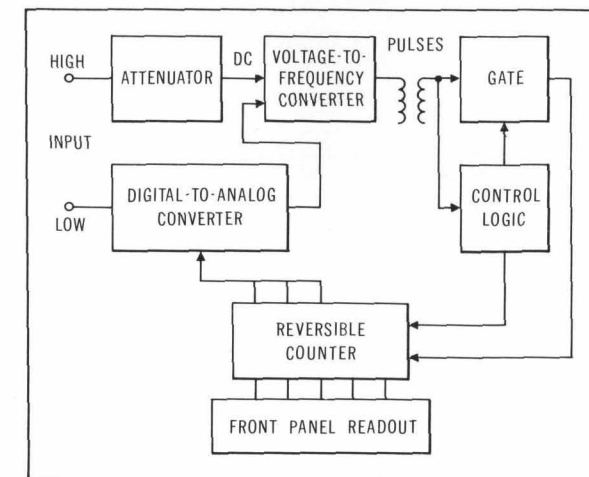
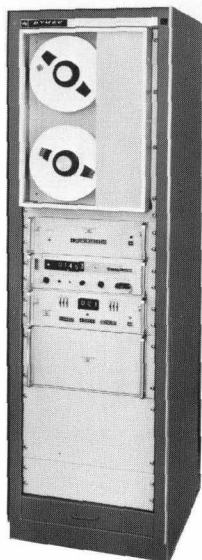

Fig. 4. Simplified block diagram of Model 3460A Digital Voltmeter. Control logic carries out sequence of operations automatically during each measurement interval.

input during the sample period.

The voltage-to-frequency conversion technique also lends itself to electrostatic guarding of the input circuits. Guarding greatly reduces errors caused by common-mode signals, providing a common-mode noise rejection of 160 dB at dc and more than 120 dB up to 60 c/s.

Typical accuracies which can be obtained with digital voltmeters of the purely integrating type are 0.01%.

THE INTEGRATING-POTENTIOMETRIC VOLTMETER

The potentiometric or null-balance technique, of course, is still the most accurate method of comparing an unknown voltage to a reference.⁴ A newly-developed digital voltmeter now combines the accuracy of the potentiometric technique with the freedom from the effects of noise that the voltage-to-frequency conversion technique can provide. The potentiometric feature allows for very accurate measurements, typically 0.005% in the new voltmeter, and integration of the input achieves insensitivity to superimposed noise. The use of the voltage-to-frequency conversion technique permits the input circuitry to be fully guarded and floating and the new voltmeter is thus virtually insensitive to common-mode signals.

The method used to combine the potentiometric technique with voltage-to-

frequency conversion permits a maximum reading rate of 15 readings per second to be attained with no loss in accuracy. This voltmeter is thus able to make accurate measurements in the presence of superimposed noise at high reading rates.

The new Digital Voltmeter, -hp- Model 3460A, is designed for use both as a precision laboratory voltmeter and as a system-oriented analog-to-digital converter. It has four voltage ranges, from 1 V to 1000 V full-scale in steps of $10\times$, with 5-digit (10 microvolt) resolution. An overranging capability enables the measurement of voltages with full accuracy up to 20% above full scale on all ranges (a 6th-place digit for 0 or 1 allows complete display of over-range voltages). Maximum sensitivity, of course, is a function of resolution, accuracy, and internal noise. Resolution on the one-volt range is $10\ \mu\text{V}$, and the accuracy of the instrument permits 1 mV to be measured with an uncertainty of only $\pm 20\ \mu\text{V}$. The internal noise contribution is negligible.

The input resistance of the new voltmeter is 10 megohms on all ranges and remains constant during the measurement cycle. The instrument has both manual and automatic modes for selecting measuring rate and range, and it is also completely programmable.

The remote control capability plus recorder output makes the new voltmeter ideally suited for systems operation (Fig. 3). Because the guarded in-

put circuitry is fully isolated from the output circuit ground, guarding is not destroyed by connecting the voltmeter to a printer or other device.

The new Digital Voltmeter is thus able to serve in a variety of measurement situations. It can serve as a secondary standard because of its extremely high accuracy, it is a useful measurement tool in many laboratory applications because of its moderate cost and flexibility, and it also functions in automatic data acquisition systems.

BASIC OPERATION

The new Digital Voltmeter achieves fast measurement rates without loss of accuracy by making each measurement in two steps. The first step is a measurement of the input voltage to provide information for the automatic setting of a precision voltage divider. The second step is a sensitive measurement of the small difference between the resulting divider output and the input voltage. As will be described later, not only does this technique achieve high resolution and accuracy, but it also reduces the time required for obtaining measurements of such accuracy.

A simplified block diagram of the new voltmeter is shown in Fig. 4. The voltage-to-frequency converter transforms a voltage at its input to a proportional pulse repetition rate at its output. The reversible counter totalizes the pulses during a fixed period of time. The total count thus is propor-

⁴ Robert E. Watson, "A Combined DC Voltage Standard and Differential Voltmeter for Precise Calibration Work," *Hewlett-Packard Journal*, Vol. 16, No. 9, May, 1965.

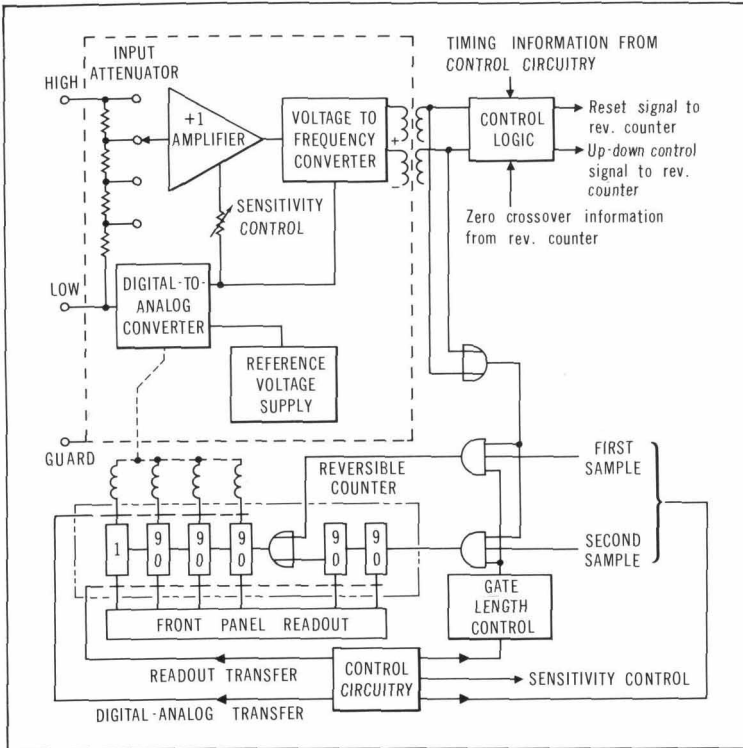

Fig. 5. Detailed block diagram of Model 3460A Digital Voltmeter. Measurement information is coupled as pulses out of guard through shielded transformers, obviating need for dc connection between input and output circuits. Information for setting digital-to-analog converter is coupled back into guard through shielded reed switches.

tional to the average value of the input voltage that existed during the totalizing period.

During the first sample period, the output of the voltage-to-frequency converter is counted for 1/60 second to derive an initial measure of the input voltage. This information is then transferred to the digital-to-analog converter without affecting the stored count.

The digital-to-analog converter output voltage, being proportional to the stored count, tends to null the input voltage (an attenuator is inserted automatically on the 10-, 100-, and 1000-V ranges). During the second sample period, which may be either 1/60 or 1/10 second, the voltage-to-frequency converter measures the residual difference voltage. Since the difference may be either positive or negative, logic circuitry senses whether counts from the voltage-to-frequency converter are to be added to or taken away from the previous stored count.

At the end of the second sample period, the final count in the reversible

counter is transferred to front panel indicators for display. A print command is also issued to permit recording of the data by external equipment.

From this brief description, it can be seen that the accuracy of the new voltmeter depends primarily upon the digital-to-analog converter. The accuracy of the voltage-to-frequency conversion is of secondary importance as far as the dc value is concerned, but the voltage-to-frequency conversion contributes significantly to reading accuracy when there is noise or other interference on the input voltage.

MEASUREMENT EXAMPLE

To illustrate the accuracy achieved by this measurement technique, the following example is presented. Assume that the voltmeter is measuring a voltage equal to +1.01935 V, a typical standard cell voltage. Assume also that the voltage-to-frequency conversion error is -0.2% (this error is typically less than $\pm 0.1\%$). The frequency being counted by the reversible counter is thus proportional to a voltage of +1.01731 volts. The counts are entered

into the third decade of the reversible counter, however, resulting in a total count of 1017 during the first sample period. Because of the familiar ± 1 -digit "counter uncertainty," we may assume furthermore that a count is lost during this first sample, making the first count actually only 1016.

The accuracy of the digital-to-analog converter output voltage with respect to the count in the reversible counter is very high, typically within 0.0015%. Assuming here that the digital-to-analog converter is in error by +0.0015%, the digital-to-analog converter generates 1.016015 volts. The difference between the input voltage and the output voltage of the digital-to-analog converter now is $+1.01935 - 1.016015 = +.003335$ volts.

The sensitivity of the voltage-to-frequency conversion is increased by a factor of 100 during the second sample period. The number of counts obtained in the second sample including the same -0.2% conversion error, thus could be 333 but since the possibility of counter uncertainty still exists, we assume that it is 332. The counter control logic causes these counts to be added to the stored counts of the first sample by way of the first decade of the reversible counter. The resulting net count after one measurement is thus $+101600 + 332 = +101932$ which, with proper placement of the decimal point gives +1.01932 volts. This value is accurate within approximately 0.003% of reading, well within the accuracy specification of the Model 3460A Digital Voltmeter.

This example demonstrates that even though the voltage-to-frequency conversion accuracy could be in error by more than 0.1%, the accuracy of the new voltmeter is determined primarily by the digital-to-analog converter.

ACCURACY CONSIDERATIONS

A number of components contribute to the overall accuracy of the new digital voltmeter but the most important of these is the zener diode used in the reference supply for the digital-to-analog converter. The diode, pretested by the manufacturer according to Hewlett-Packard specifications, has a temperature coefficient of 0.002%/°C.

Selected diodes, after they are re-

ceived by Hewlett-Packard, are installed with other critical circuitry in a temperature-controlled oven that has a temperature stability of approximately 0.2°C throughout an ambient temperature range of 0 to 55°C. After the reference supplies have been assembled and tested (they are not yet part of the voltmeter) their stability is observed for 1000 hours. To be acceptable, the reference voltage must not change more than 0.001% during the first two weeks of observation, and no more than another 0.001% during the remainder of the test. Fig. 2 illustrates the stabilities of typical reference supplies during the 1000-hour test.

Another important contribution to voltmeter accuracy is made by the precision wirewound resistors used in the

reference supply, in the digital-to-analog converter, and in the input attenuator. These resistors are used to best advantage in these areas, i.e., as voltage dividers, a usage that makes the relative temperature coefficient and long term stability much more important than the absolute magnitude of these characteristics. The specified long term stability of these resistors, all manufactured by Hewlett-Packard, is 40 ppm per year but typically it has been less than 20 ppm per year.

CIRCUIT ARRANGEMENTS

A more detailed block diagram of the Model 3460A Digital Voltmeter is shown in Fig. 5. As shown in this diagram, the guard encloses the input attenuator, the digital-to-analog converter and its reference supply, the

plus-1 amplifier and sensitivity control resistors and, finally, the voltage-to-frequency converter. The plus-1 amplifier converts the voltage at its input (the difference between the voltage from the input attenuator and the digital-to-analog converter output) into a proportional current for operation of the voltage-to-frequency converter. The voltage-to-current sensitivity or "transconductance" of the plus-1 amplifier is determined by the sensitivity control resistors.

The voltage-to-frequency converter is polarity sensitivity and it has a separate output for each polarity of input current. Two triple-shielded pulse transformers couple the outputs through the guard to the reversible counter outside the guard. Because the

GUARDED MEASUREMENTS WITH A FLOATING VOLTMETER

Whenever a voltage measurement is to be made on a transducer or other source located at some distance from the voltmeter, inaccuracies can be expected as a result of unwanted interference that becomes mixed with the voltage to be measured. Obviously, interference from electrostatic pickup can be reduced by the use of shielded conductors, and magnetic pickup is reduced by periodic transposition of the conductors (i.e., twisted pair).

The effects of ground loops are not so easily dealt with and become more severe as the lengths of cable runs increase. As shown in the accompanying diagram, ac potentials most likely exist between any separated earth grounds. Current flows in the loop formed by the leads and the leakage resistance and stray capacitance that inevitably exist between the voltmeter's input circuits and ground. If there is any unbalance in the measuring system, currents through the ground loops will develop a voltage differential in the measurement circuits.

The benefits of a guarded voltmeter can be shown by referring to the accompanying diagram. Assume for the moment that the guard is not connected to the low side of the unknown voltage to be measured (S1 open). The effective impedance between the low terminal of a digital voltmeter, such as the Model 3460A, and its power ground would be typically 2×10^9 ohms in parallel with 1000 pF.

The ac common-mode voltage is shown here to be 10 volts ac RMS, a typical value for situations in which the digital voltmeter, and its power ground, is some distance from the unknown voltage to be measured and its power ground. The ac common-mode voltage causes current to flow through the 1 k resistor that represents an unbalance in the measuring system, resulting in a 3.9 mV RMS voltage drop across the resistor. This voltage drop

will introduce errors into the reading depending upon the nature of the voltmeter's analog-to-digital converter.

Now consider the situation when the guard of the Model 3460A Digital Voltmeter is connected to the low side of the unknown voltage to be measured (S1 closed). The common-mode voltage "drives" the guard, bringing the guard and the low side of the measurement circuits to the same potential. Practically no current then flows through the impedance which exists between low and ground. The effective impedance between low and ground is now 10^{11} ohms in parallel with 1 pF and the ac common-mode signal causes a voltage drop across the 1 k resistor of only 3.8 μ V RMS. This amount of superimposed noise is easily dealt with by integration of the input signal, especially in the vicinity of 60 cycles.

Consider now the case when the voltmeter is connected for a floating measurement with the low side of the input con-

nected at some dc potential with respect to ground, as suggested by the 200 V dc indicated in the diagram. With the guard disconnected (S1 open), the leakage paths allow current to flow through the 1 k resistor that represents unbalance. The current causes a .1 mV drop across the resistor, a voltage that is in series with the voltage to be measured and which represents a full scale error of .01% on the 1-volt range.

With the guard connected (S1 closed), there would be a dc voltage drop of only 2 μ V across the unbalance resistor, equivalent to a full scale error of 0.0002% on the 1-volt range. In those cases where leakage current from guard to ground would affect the voltage of the source, the guard may be connected to a separate voltage divider that places the guard at the same potential as the low side of the source being measured. Leakage currents are then confined to circuits external to the measuring circuits.

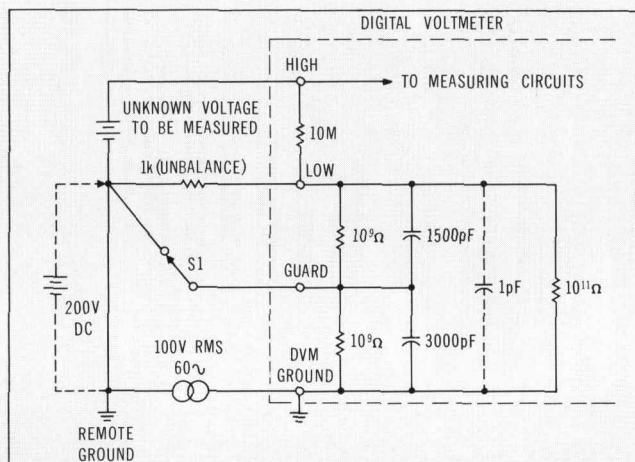



Fig. 6. —hp— Model 3460A Digital Voltmeter has 5-digit resolution but includes 6th digit to permit display of 20% overranging. Input may be through banana-plug jacks on front panel or through guarded connector on rear panel. Measurements are initiated automatically at repetitive rates selectable between 3 per second to 1 per 5 seconds, or singly by front panel pushbutton, or by remote control. Measurement ranges may be selected manually, automatically, or by remote control.

measurement information is in the form of pulses at this point, dc isolation of the circuitry inside the guard is easily achieved.

Logic circuitry, having as its inputs the pulses coming from the v/f converter (only one output of the v/f converter is in operation at any given time) and an indication from the reversible counter when it has reached a condition of zero count, determines whether the reversible counter counts up or counts down.

The gate which permits pulses from the voltage-to-frequency converter to pass to the reversible counter is open for only 1/60 second during the first sample. Control circuitry bypasses the first two decades of the reversible counter and enters counts into the third decade during the first sample.

The net result of the first sample is a 3-digit (a fourth digit for 20% overranging) measurement of the input voltage. During the first transfer period, the count accumulated in the four most-significant decades is stored and it is also transferred to the digital-to-analog converter. This information is coupled back into the guard by means of shielded reed switches.

The voltage from the digital-to-analog converter tends to null the voltage from the input attenuator. Before the beginning of the second sample period, the sensitivity of the input circuitry is increased by a factor of 100 and the output of the voltage-to-frequency converter is entered into the first decade of the counter. The two least signifi-

cant digits of the reading, plus any correction in the following digits, are thus obtained.

Following the end of the second sample period, the total count accumulated in the reversible counter is transferred to the front panel readout for display. It is also made available in BCD form at the printer output.

The second transfer period may be as short as 15 ms when the voltmeter is operating at its maximum reading rate, or it may be extended indefinitely by the front panel TRIGGERING RATE CONTROL.

SPEED CONSIDERATIONS

One factor which permits the high reading rate of the new voltmeter is the skipping of two decades during the first sample, as just described. Another feature of the measuring technique is that the reed switches in the digital-to-analog converter are all switched simultaneously. As a result, the first transfer period need be only 16 ms long.

Total duration of the two transfer periods plus the two 1/60 second sample periods is less than 66.7 ms, equivalent to a reading rate of 15 per second. On the one-volt range, however, the second sample is forced by system logic to be 1/10 second. With this the only difference, the maximum reading rate on the one-volt range is approximately 7 per second. The longer second sample on the one-volt range improves the noise referred to the input.

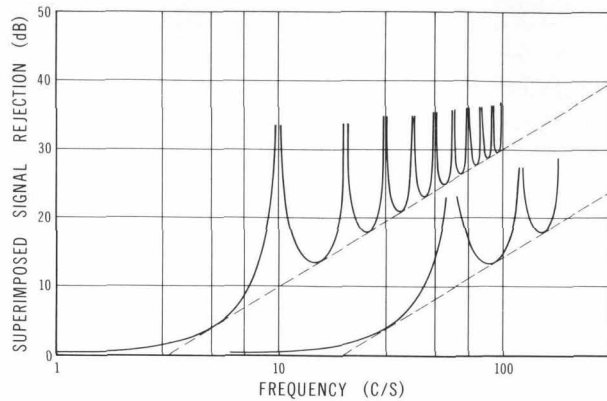

Fig. 7. Graphs show, on dB scale, ratio of peak magnitude of superimposed signals with respect to actual effect on dc readout. Upper curves, for 1/10 second integration interval, show infinite rejection at 10 c/s and every multiple of 10 c/s. Lower curves for 1/60 second integration interval, show infinite rejection at 60 c/s and every multiple thereof. Upper curve always applies to 1-volt range and also when voltmeter is not programmed to read at maximum rate. Lower curve applies only when second sample is programmed for maximum reading rate on 10-, 100-, or 1000-volt ranges.

INTEGRATION CAPABILITIES

The noise rejection achieved by integration in the new voltmeter is shown in Fig. 7. As the figure shows, noise rejection is a function of the length of the second sample and also of the frequency components of the noise. If the second sample is 1/10 second, superimposed signals at frequencies of 10 c/s and every multiple thereof are subject to infinite rejection, as shown by the cusps of the curves. The rejection of frequencies which lie between the peaks of maximum rejection is larger for the longer sample period.

The increased sensitivity of the voltage-to-frequency converter during the second sample period causes the converter to run near its maximum frequency, i.e., almost 100 kc/s, with a voltage at its input much smaller than full scale in value. If the second sample is 1/60 second in length, an unbalance of 1% of full scale causes the voltage-to-frequency converter to run at 60 kc/s. Superimposed noise appears directly on the unbalance voltage, thus placing limits on the amount of noise that can be tolerated. When the second sample is 1/10 second in length, the v/f sensitivity is changed to obtain the proper scale factor. An unbalance of 6% of full scale is then required to make the converter run at 60 kc/s. The longer gate therefore should be used if the instantaneous value of superimposed noise exceeds 1% of full scale.

When the new voltmeter is not being used in a system, and there is no remote programming, the second sample on all ranges automatically becomes 1/10 second. When the instrument is used in a system, the second sample on the three higher ranges can be selected to be either 1/10 second or 1/60 second.

FINAL CALIBRATION

Special procedures were developed for the new voltmeter to permit factory calibration better than $\pm 0.0015\%$ of reading, $\pm 0.0005\%$ of full scale. The voltmeters are calibrated with a precision voltage divider and a DC Standard, as shown by the setup in Fig. 8. Note that the special divider has several input taps. The input voltage to a given tap is calibrated by comparison of the 1.000-volt output to a transfer standard using a sensitive null meter. The uncertainty in the voltage division is 7 ppm and the contribution of the null meter to the total uncertainty is typically less than 1 ppm.

The transfer standard is compared in the primary standards laboratory to saturated cells (periodically certified by NBS) using the same null voltmeter. This intercomparison also has an uncertainty of 1 ppm. By allowing an additional 2 ppm for the transfer standard, because of possible environmental conditions, the total uncertainty of the divider input voltage is 11 ppm or $.0011\%$ with respect to the house standard.

Once the output of the DC Standard is established to this high degree of accuracy, the digital voltmeter being calibrated is adjusted so that its reading agrees with the standard.

ACKNOWLEDGMENTS

The design of the *-hp-* Model 3460A Digital Voltmeter originated in the *-hp-* Advanced Research and Development Laboratories under the supervision of Dr. Paul Stoft and it was brought to production status at the *-hp-* Loveland Engineering Laboratories in the digital equipment section directed by Donald Schulz. The integrating-potentiometric technique was developed by Edward Holland of the *-hp-* A R and D Laboratories. Others contributing to the electronic design of the instrument were William Kay, Edward Heinsen, Harold Briggs, and

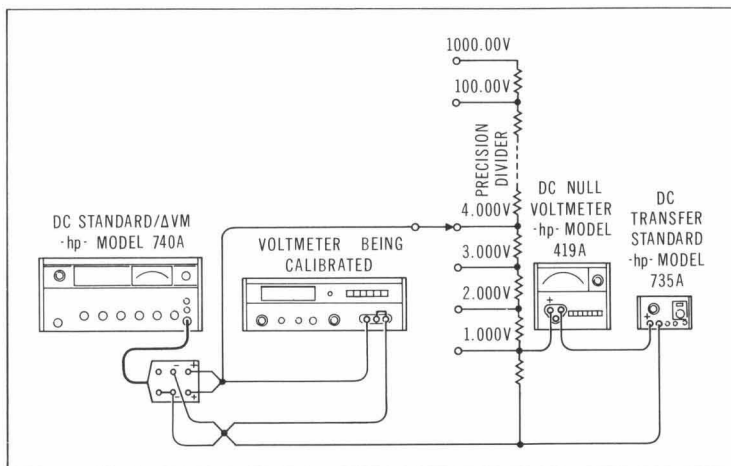

Fig. 8. Block diagram of set-up for factory calibration of new digital voltmeter. Configuration here enables calibration of digital voltmeter within ± 8 ppm of transfer standard. Transfer standard is maintained within ± 3 ppm with respect to house standard.

the undersigned. Those contributing to the mechanical design were Stuart Kingman, Robert Kingston, Jerry Blanz, and John Becker. The zener

diode evaluation was carried out by Frank Lee.

—William McCullough
Biographical sketch of author, P. 8.

SPECIFICATIONS

-hp-

MODEL 3460A-

DIGITAL VOLTMETER

RANGES: Full scale presentation of ± 1.00000 , ± 10.0000 , ± 100.000 , and ± 1000.00 (up to 20% overranging indicated by 6th digit). Range selection may be made automatically, remotely, or manually. Polarity selection is automatic.

PERFORMANCE RATING:

VOLTAGE ACCURACY: $\pm 0.005\%$ of reading $\pm 0.002\%$ of full scale from $+10^\circ\text{C}$ to $+40^\circ\text{C}$ on all ranges, $\pm 0.01\%$ of reading $\pm 0.003\%$ of full scale from 0 to $+10^\circ\text{C}$ and from $+40$ to $+50^\circ\text{C}$.

LONG-TERM STABILITY: Voltage accuracy guaranteed for 60 days. Stabilities of internal reference and resistance ratios are typically $\pm 0.001\%$ for 30 days.

RESPONSE TIMES:

On fixed range — reads within specifications if triggered to read coincident with step input voltage.

Reading period — 66 ms on 10-, 100-, and 1000-V ranges, 150 ms minimum on 1-V range.

Polarity selection — no delay.

Automatic range selection — 33 ms per range change.

Remote range selection — 8 ms.

INPUT CHARACTERISTICS:

INPUT RESISTANCE: 10 megohms $\pm 0.03\%$ (to dc) on all ranges.

INPUT IMPEDANCE: 40 pf in parallel with 10 megohms at front panel.

ISOLATION PARAMETERS:

INPUTS: Floated and guarded signal pair (front panel switch selects binding posts on front panel or connector on rear panel). Guard may be operated up to ± 500 V above chassis ground (350 volts rms). Low may be operated up to ± 50 V above guard.

COMMON MODE REJECTION (ratio of common mode signal to resultant superimposed signal with a 1-k ohm unbalance at input): 160 dB at dc and 120 dB up to 60 c/s.

INPUT SIGNALS:

RANGE SELECTION:

Automatic: Pushbutton selector or switch closure of less than 100 ohms to ground provides auto range operation.

Remote: Switch closure of less than 100 ohms to ground for period $> 100 \mu\text{s}$ selects range desired.

Manual: Pushbutton selector.

EXTERNAL READ COMMANDS: Any of 4 lines (plus ground) triggers voltmeter to take a reading.

AC-coupled (either polarity) — requires 20-V p-p signal with rise time $< 10 \mu\text{s}$.

Positive dc — change in voltage from -10 V to a level between $+10$ and $+30$ V triggers a reading.

Negative dc — change in voltage from $+10$ V to a level between -10 and -30 V triggers a reading.

READING PERIOD: Voltmeter normally integrates for $\frac{1}{2}$ second. Switch closure with impedance < 100 ohms to ground selects $\frac{1}{2}$ second integration period (10-, 100-, and 1000-V ranges only).

OUTPUT SIGNALS:

PRINT COMMAND: DC-coupled.

Print level: -1.0 volt with 2k ohm source resistance.

Print hold-off level: -17 volts with 2k ohm source resistance.

BCD OUTPUTS: 4-line BCD (1-2-4-8) 9 columns consisting of POLARITY, DECIMAL LOCATION, OVERLOAD, and 6 digits of data (Option 01 or 03 are available for 1-2-2-4 BCD). BCD code is "1" state positive.

GENERAL

POWER: 115 or 230 volts $\pm 10\%$, 50 to 60 c/s. Approximately 60 watts. Available on special order for operation with power line frequencies between 50 to 1000 c/s.

SIZE: Nominally 5 in. high, 16 $\frac{3}{4}$ in. wide, 21 $\frac{1}{2}$ in. deep (127 x 406 x 543 mm).

WEIGHT: Net: 38 lbs. (16 kg). Shipping: 43 lbs. (19.6 kg).

PRICE:

-hp- Model 3460A: \$3600.00

OPTION 01: 1-2-2-4 BCD output, no extra charge.

OPTION 02: Replacement printed circuit board and Nixie tube for AC voltage and resistance measurements using Dymec 2410B-M22 AC/Ohms Converter. Function symbol (Nixie) indicates all modes of operation. 1-2-4-8 BCD output. Add \$250.00.

OPTION 03: Same as option 02 except 1-2-2-4 BCD output.

Prices f.o.b. factory.

Data subject to change without notice.

VOLTMETER DESIGN LEADERS

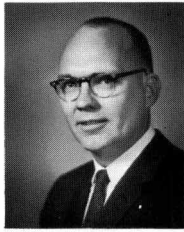

William McCullough

Bill McCullough joined Hewlett-Packard in 1959 as a development engineer. His first assignment was in the development of transistorized power supplies, projects that resulted in —hp— Models 722A and 726A Transistorized Power Supplies and a patent on a new type of current limiter. In 1961, Bill was assigned as a project leader in digital voltmeter development with the —hp— Model 3460A as his main responsibility. The project was transferred to the engineering laboratories of the Loveland Division in 1964, where Bill is presently a group leader in digital voltmeter development.

Bill received a BSEE and the University of Notre Dame and an MSEE degree from the University of California at Berkeley. Before joining —hp—, he spent three years as a development engineer working on feedback amplifiers and stable crystal oscillators.



Edward Holland

Ed Holland joined Hewlett-Packard as a development engineer in 1961 and was assigned initially to the digital voltmeter development group in the Advanced Research and Development Laboratories. As part of this work, he proposed the integrating-potentiometric technique on which he has been issued a patent. Following transfer of the Model 3460A Digital Voltmeter to the Loveland Division, Ed remained in Palo Alto working in the area of advanced digital projects. He recently transferred to the Dymec Division of Hewlett-Packard to continue work on digital instrumentation.

Prior to joining —hp—, Ed spent three years as an engineering specialist in the United States Navy, and six years in the design of special test equipment and automatic missile check-out systems. He received his BSEE degree from Michigan State University and an MSEE degree from Stanford University, and he has done further graduate study at Stanford toward the degree of Electrical Engineer.

CABLE TESTING WITH TIME DOMAIN REFLECTOMETRY

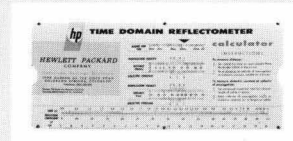
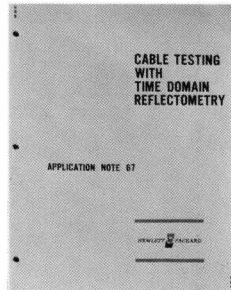

AMONG MANY other important uses, time domain reflectometry (TDR) has proved to be a rapid, accurate, and convenient technique for analyzing the performance of coaxial cables. TDR has been especially useful for multi-cable installations, such as in ships or aircraft, where it is highly important to pinpoint the exact location and the nature of defects in long cables. TDR eliminates the necessity for physically examining every part of a cable to locate breaks, physical deformations, or other injuries detrimental to satisfactory performance.

Time Domain Reflectometry uses pulse-echo techniques to locate points of impedance changes in transmission systems¹ and has been described as "one-dimensional" or "closed-loop" radar. The TDR system repetitively launches a fast voltage step into a cable or coaxial system under test; impedance changes along the line reflect some of the energy and the reflections are viewed on a cathode-ray tube. Because of the finite speed of electromagnetic energy in cables, discontinuities separated in space are separated in time, and appear as individual responses on the CRT. Furthermore, the shape and magnitude of each reflection tells what kind of discontinuity is present.

Hewlett-Packard has been developing equipment for time domain reflectometry ever since the advantages of the —hp— Sampling Oscilloscopes in this application were recognized.² The fast step generator and sampling channel needed for precise TDR measurements have been designed into a single calibrated unit for TDR work, the —hp— Model 1415A TDR Plug-in for the —hp— Model 140A Oscilloscope.³ The usefulness of this system has recently been enhanced by the addition of an automatic slow scan for X-Y recording and adjustable interference controls to improve the

trace when there is noise or other interference on the cables under test.

Time Domain Reflectometry has proved to be of inestimable value in quickly locating cable faults in large installations. For example, TDR showed exactly where to examine a cable in an antenna tower to find a cable injury caused by a rifle bullet. It has determined exactly where anomalies exist in cables in aircraft, eliminating the need for large-scale dismantling of the structure to find the faults. Furthermore, TDR indicates the nature of each anomaly, such as that caused by a tightly-squeezed cable clamp. TDR evaluation of coaxial cables in a naval vessel showed that cable impedances changed in a certain area, which turned out to be in the vicinity of steam pipes that had softened the cable dielectric.

Techniques for applying TDR to cable testing are described in a new application note ("Cable Testing with Time Domain Reflectometry," —hp— Application Note No. 67) available without charge from Hewlett-Packard. This application note discusses the basic theory of cable testing with Time Domain Reflectometry and includes discussions of techniques for obtaining high accuracy in lossy lines, for making corrections when there are multiple discontinuities, and for minimizing interference when unwanted signals are on the lines.

A new slide rule calculator, which simplifies some of the calculations that may be required in cable testing, is included with the application note. The calculator has two primary functions: it adjusts distance readings in either meters or feet to account for the differing dielectric constants, and hence propagation velocities, of various kinds of coaxial cables; and it provides a direct indication of the impedance of a section of line or discontinuity.

Interested engineers may obtain a copy of Application Note No. 67, including calculator, by contacting the nearest —hp— Field Office or by writing:

Hewlett-Packard
Colorado Springs Division,
1900 Garden of the Gods Road,
Colorado Springs, Colorado 80907.

¹ B. M. Oliver, "Time Domain Reflectometry," *Hewlett-Packard Journal*, Vol. 15, No. 6, Feb., 1964.

² Harley Halverson, "Testing Microwave Transmission Lines Using the Sampling Oscilloscope," *Electronics*, Vol. 34, No. 26, June 30, 1961.

³ Lee R. Moffitt, "The Time Domain Reflectometer," *Hewlett-Packard Journal*, Vol. 15, No. 1, Sept., 1963.